

AMERICAN FYRE DESIGNS™

outdoor products collection



American Fyre Designs™ • 2016 Product Catalog • RH Peterson Co.

RH PETERSON co.

CRAFTED WITH PRIDE  IN THE USA





AMERICAN FYRE DESIGNS™

Outdoor Products Collection

Homeowners all over the country have come to realize the allure of fire in their backyards. Fire brings warmth, glow and serenity, encouraging us to relax and unwind. An American Fyre Designs™ exterior fire feature will anchor your outdoor living space and turn your patio into an outdoor sanctuary inviting conversation that flows well into the night – even when there is chill in the air.

From fireplaces perfect for cuddling up under the stars, to fire tables ideal for entertaining, to fire falls that combine the charm of fire with running water, each product is expertly crafted from innovative glass fiber reinforced concrete (GFRC). GFRC derives its strength from a dosage of alkali-resistant glass fiber and acrylic polymer that results in durable concrete to withstand the outdoor elements. Modularly constructed as easy-to-assemble components, American Fyre Designs™ products fit easily into most backyards, making installation fast and simple.

American Fyre Designs™ products are available in a variety of styles, colors and textures to complement any décor. Warm your outdoor living area with American Fyre Designs™.

Fireplaces



Pictured above: Grand Cordova Fireplace (882-35-H-CB-xxC) in Café Blanco Finish with Charred Oak log set (CHDG45-24)

Create an enticing outdoor setting with the American Fyre Designs™ Outdoor Fireplaces. Expertly handcrafted from innovative glass fiber reinforced concrete (GFRC), a variety of styles, finishes and options are available to find the right fireplace for your setting.

The Grand Series Fireplaces incorporate wall extension panels to create a more impressive design while keeping the same style and look of the fireplace. Wall extension panels expand upon the body of the Fireplace to create many new decorating opportunities while also providing a beautiful separation to the world behind the fireplace.

Most fireplaces are available in vent-free versions which permit you to locate your fireplace in a lanai or other covered outdoor area.

Feature Highlights

- Modularly constructed as easy-to-assemble components
- Exterior may be recessed to accommodate field cladding in tile, stone or other veneer
- Most fireplaces available as Vented or Vent-Free
- All Vent-Free fireplaces are blocked at the top and throat of the firebox
- All Fireplaces include herringbone firebox liners



Grand Phoenix

Model Shown: 818-05-N-SD-xxC
 Finish Shown: SD, Sedona
 Dimensions: 113" w x 36" d x 87" h



Grand Cordova

Model Shown: 882-35-N-CB-xxC
 Finish Shown: CB, Café Blanco
 Dimensions: 110" w x 41" d x 95" h



Grand Mariposa

Model Shown: 868-05-N-SD-xxC
 Finish Shown: SD, Sedona
 Dimensions: 113" w x 36" d x 67" h



Grand Petite Cordova

Model Shown: 865-10-N-TS-xxC
 Finish Shown: TS, Tuscan Slate
 Dimensions: 127" w x 36" d x 84" h

Fireplace venting options **V** = Vented **VF** = Vent Free

See pages 34-39 for available media, accessories and finish options



Cordova

Model Shown: 022-20-N-CB-xxC
 Finish Shown: CB, Café Blanco
 Dimensions: 76" w x 41" d x 95" h



Petite Cordova

Model Shown: 025-01-N-CB-xxC
 Finish Shown: CB, Café Blanco
 Dimensions: 65" w x 36" d x 84" h



Reduced Cordova

Model Shown: 023-20-N-CN-xxC
 Finish Shown: CN, Canyon
 Dimensions: 76" w x 41" d x 82" h



Mariposa

Model Shown: 073-01-N-CB-xxC
 Finish Shown: CB, Café Blanco
 Dimensions: 65" w x 36" d x 67" h



Phoenix

Model Shown: 017-01-N-SM-xxC
 Finish Shown: SM, Smoke
 Dimensions: 65" w x 36" d x 87" h



Phoenix w/back venting

Model Shown: 015-01-N-SD-xxC
 Finish Shown: SD, Sedona
 Dimensions: 65" w x 36" d x 57" h

Fireplace venting options  = Vented  = Vent Free



Chica

Model Shown: 010-11-N-TS-xxC
 Finish Shown: TS, Tuscan Slate
 Dimensions: 47" w x 30" d x 67" h



Manhattan*

Model Shown: 082-SB-N-SM-LBxC
 Finish Shown: SM, Smoke
 Shelf Shown: SB, Smooth Black
 Dimensions: 59" w x 32" d x 42" h

Fireplaces may be ordered with recessed hearth and/or body to accommodate field cladding in tile, stone or other veneer.



Reduced Cordova Fireplace with slate tile veneer



Mariposa Fireplace with stacked stone veneer



Contractor's Model

Model Shown: 040-11-A-WC-RBC
 Finish Shown: WC, White Concrete Only!
 Dimensions: 67" w x 37" d x 96" h



Contractor's Model w/moulding

Model Shown: 045-11-A-WC-RBC
 Finish Shown: WC, White Concrete Only!
 Dimensions: 67" w x 37" d x 93" h

The Contractor's Model comes with an unfinished surface to customize the exterior in your choice of surface veneer.



Contractor's Model Fireplace with stone veneer

Fireplace venting options = Vented = Vent Free

*Not available with recessed hearth. Choose Natural Gas or Propane.

Firefalls



Multi-color LED lights on Firefalls



Glass Wind Guards included with Large Firefalls



Pictured above: Small Firefall (698-SD-11-V5xC) in Sedona Finish with Lavender Diamond Nuggets (GLD-xx-L)

The Firefall features cascading water down the backdrop, dancing flames in the front, and a strip of LED lights set into the inner arch to spotlight the water. Available in both a large and a small size; the large features an arched upper mantle and recessed side panels while the small has a flat top. This piece is handcrafted from glass fiber reinforced concrete (GFRC) and comes in a variety of different colors and textures.

In addition, The Arch Stone Firewall features an open fire area with no firebox and a recessed arched backdrop. Unlike the Firefalls, this piece does not have a water feature or LED lights and is only available in the Heavy Texture Finishes.

V4 & V5

Linear Burners

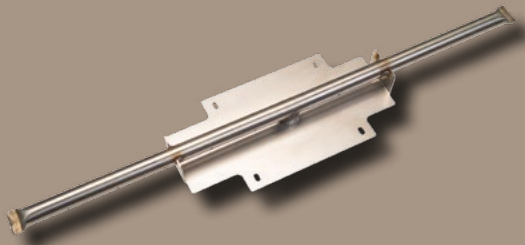

Feature Highlights

- Handcrafted from innovative Glass Fiber Reinforced Concrete (GFRC)
- Cascading water feature (*Firefalls only*)
- Multi-color LED lights (*Firefalls only*)
- Glass Wind Guard included with Large Firefalls
- Access door to accommodate a 5 gal. Propane tank inside the unit (*Large Firefall and Firewall*)
- Available for Natural Gas or Propane



Large Firefall

Model Shown: 693-CB-12-V5xC
 Finish Shown: CB, Café Blanco
 Dimensions: 65" w x 27 ¾" d x 73" h
 BTU ratings: 45,000 (NG) / 45,000 (LP)



Small Firefall

Model Shown: 698-SD-12-V5xC
 Finish Shown: SD, Sedona
 Dimensions: 47 ½" w x 25 ¾" d x 51 ½" h
 BTU ratings: 35,000 (NG) / 35,000 (LP)



Arch Stone Firewall (*No water*)

Model Shown: 092-CB-12-V4xC
 Finish Shown: CB, Café Blanco
 Dimensions: 60" w x 26" d x 60" h
 BTU ratings: 60,000 (NG) / 50,000 (LP)
 Available in Heavy Texture Finishes only

Small and Large Firefalls include water reservoir, PVC piping, pump, low voltage transformer/timer, and LED lights

Firetables



Pictured above: Fiesta Firetable (770-CB-11-V2xC) in Café Blanco Finish with Copper Reflective Fyre Glass (2-GL-10-QR)

Our Firetables create the perfect ambiance for enjoying an outdoor meal or cocktail while also keeping you warm from the evening chill. Select models are also available with an optional granite insert top. Fuel options include Natural Gas or self-contained Propane tank (most include a removable door to house a 5 gallon Propane tank inside). Handcrafted from glass fiber reinforced concrete (GFRC).

V2
12" Burner



V4
24" Burner

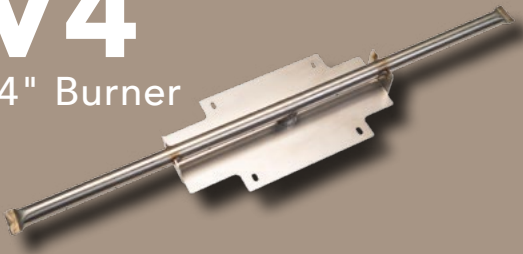

Feature Highlights

- Handcrafted from innovative Glass Fiber Reinforced Concrete (GFRC)
- Stainless steel burners
- Tropical Brown granite inserts table top option (*Amphora, Inverted, and Octagon Firetables only*)
- Access door to accommodate a 5 gal. Propane tank inside the unit (*excluding Contempo & Versailles Firetables*)
- Adjustable flame height for comfortable dining
- Available for Natural Gas or Propane



Amphora Firetable

Model Shown: 610-TS-11-V2xC
Finish Shown: TS, Tuscan Slate
Dimensions: 48" dia x 24" h
BTU ratings: 60,000 (NG) / 50,000 (LP)



Inverted Firetable

Model Shown: 630-SL-21-V2xC
Finish Shown: SL, Silverado (w/granite inserts)
Dimensions: 48" dia x 24" h
BTU ratings: 60,000 (NG) / 50,000 (LP)



Octagon Firetable

Model Shown: 626-CB-11-V2xC
Finish Shown: CB, Café Blanco
Dimensions: 54" dia x 24" h
BTU ratings: 60,000 (NG) / 50,000 (LP)



Cosmopolitan Round Firetable

Model Shown: 645-BA-11-V2xC
 Finish Shown: BA, Black Lava
 Dimensions: 48" dia x 24" h
 BTU ratings: 60,000 (NG) / 50,000 (LP)



Cosmopolitan Square Firetable

Model Shown: 640-SM-11-V2xC
 Finish Shown: SM, Smoke
 Dimensions: 36" w x 36" d x 24" h
 BTU ratings: 60,000 (NG) / 50,000 (LP)



Cosmopolitan Rectangle Firetable

Model Shown: 635-SL-11-V4xC
 Finish Shown: SL, Silverado
 Dimensions: 54" w x 36" d x 24" h
 BTU ratings: 60,000 (NG) / 50,000 (LP)



Contempo Round Firetable*

Model Shown: 782-SM-11-V2xC
 Finish Shown: SM, Smoke
 Dimensions: 47" dia x 15 1/2" h
 BTU ratings: 60,000 (NG) / 50,000 (LP)



Contempo Square Firetable*

Model Shown: 784-SM-11-V2xC
 Finish Shown: SM, Smoke
 Dimensions: 44" w x 44" d x 15 1/2" h
 BTU ratings: 60,000 (NG) / 50,000 (LP)



Contempo Rectangle Firetable*

Model Shown: 783-SM-11-V4xC
 Finish Shown: SM, Smoke
 Dimensions: 52" w x 36" d x 15 1/2" h
 BTU ratings: 60,000 (NG) / 50,000 (LP)

*Cannot accommodate a Propane tank inside the unit, see pg. 38 for tank housing options.



Lotus Firetable*

Model Shown: 653-CB-13-V2xC
 Finish Shown: CB, Café Blanco (w/Polished Top)
 Dimensions: 48" dia x 20" h
 BTU ratings: 60,000 (NG) / 50,000 (LP)



Fiesta Firetable

Model Shown: 770-CB-11-V2xC
 Finish Shown: CB, Café Blanco
 Dimensions: 54" dia x 25" h
 BTU ratings: 60,000 (NG) / 50,000 (LP)



Rectangular Firetable

Model Shown: 650-SD-11-V4xC
 Finish Shown: SD, Sedona
 Dimensions: 48" w x 27" d x 23" h
 BTU ratings: 60,000 (NG) / 50,000 (LP)



Voro Firetable

Model Shown: 725-BA-11-V2xC
 Finish Shown: BA, Black Lava
 Dimensions: 36" w x 36" d x 24" h
 BTU ratings: 60,000 (NG) / 50,000 (LP)



Versailles Firetable*

Model Shown: 744-SM-11-V6xC
 Finish Shown: SM, Smoke
 Dimensions: 54" dia x 16" h
 BTU ratings: 65,000 (NG) / 60,000 (LP)

*Cannot accommodate a Propane tank inside the unit, see pg. 38 for tank housing options.



Dining & Bar Firetables

Our Dining Firetables create the perfect ambiance for enjoying an outdoor meal or cocktail while also keeping you warm from the evening chill. Handcrafted from glass fiber reinforced concrete (GFRC), all Dining Firetables provide access to house a 5 gallon Propane tank inside. Select models are also available with an optional granite insert top. Fuel options include Natural Gas or Propane.

Pictured above: Inverted Dining Height Firetable (676-SL-21-V2xC) in Silverado Finish with Tropical Brown granite inserts and Copper Reflective Fyre Glass (2-GL-10-QR)



Elliptical Dining Firetable

Model Shown: 651-CB-13-V4xC
Finish Shown: CB, Café Blanco (w/polished top)
Dimensions: 82" w x 58" d x 30" h
BTU ratings: 60,000 (NG) / 50,000 (LP)



Inverted Dining Firetable

Model Shown: 676-SL-21-V2xC
Finish Shown: SL, Silverado (w/granite inserts)
Dimensions: 60" dia x 29" h
BTU ratings: 60,000 (NG) / 50,000 (LP)



Lotus Dining Firetable

Model Shown: 652-BA-13-V2xC
Finish Shown: BA, Black Lava (w/polished top)
Dimensions: 48" dia x 29" h
BTU ratings: 60,000 (NG) / 50,000 (LP)



Cosmopolitan Square Din. Firetable

Model Shown: 642-SM-11-V6xC
Finish Shown: SM, Smoke
Dimensions: 60" w x 60" d x 29" h
BTU ratings: 65,000 (NG) / 60,000 (LP)



Fiesta Dining Firetable

Model Shown: 775-CB-11-V2xC
Finish Shown: CB, Café Blanco
Dimensions: 54" dia x 28" h
BTU ratings: 60,000 (NG) / 50,000 (LP)



Lotus Bar Firetable

Model Shown: 655-CB-13-V2xC
Finish Shown: CB, Café Blanco (w/polished top)
Dimensions: 48" dia x 42" h
BTU ratings: 60,000 (NG) / 50,000 (LP)

Fire Bowls



Pictured above: 36" Fire Bowl (732-CB-11-V6xC) in Café Blanco Finish with Copper Reflective Fyre Glass (2-GL-40-QR)

American Fyre Designs™ Fire Bowls are the hottest trend right now because of their simple, contemporary design and versatility of uses. With a variety of different styles and sizes, these Fire Bowls are easily incorporated into any style or size of outdoor space. The Fire Bowls have a riser at the bottom to elevate them slightly off the ground. Handcrafted from glass fiber reinforced concrete (GFRC), the Fire Bowls come in a variety of different colors and textures. Choose Natural Gas or Propane.

V6

16" Star Burner



Feature Highlights

- Contemporary design
- Handcrafted from innovative Glass Fiber Reinforced Concrete (GFRC)
- 16" stainless steel burner
- Available for Natural Gas or Propane
- 48" Fire Bowl includes a removable door to house a 5 gal. Propane tank (see pg. 38 for tank housing options for 36" & 32" Fire Bowls)



48" Fire Bowl

Model Shown: 731-CB-11-V6xC

Finish Shown: CB, Café Blanco

Dimensions: 48" dia x 22" h

BTU ratings: 65,000 (NG) / 60,000 (LP)

Accepts a 5 gal. Propane tank inside the unit (not included)



36" Fire Bowl

Model Shown: 732-SD-11-V6xC

Finish Shown: SD, Sedona

Dimensions: 36" dia x 16" h

BTU ratings: 65,000 (NG) / 60,000 (LP)



32" Fire Bowl

Model Shown: 733-SM-11-V6xC

Finish Shown: SM, Smoke

Dimensions: 32" dia x 16" h

BTU ratings: 65,000 (NG) / 60,000 (LP)

Versailles Fire Bowls



*Pictured above:
2 - 48" Versailles Fire Bowls with Water Spouts (741-CB-80-V6xC) in Café Blanco Finish & 2 - 54" Pedestals (8654-CB) in Café Blanco Finish*

Pictured above: 48" Versailles Fire Bowl (741-SD-11-V6xC) in Sedona Finish with Lava Coals (LFC-10)

Versailles Fire Bowls offer a low profile with ball feet, and a wide opening to accommodate more and varied fire media. Handcrafted from glass fiber reinforced concrete (GFRC), the Versailles Fire Bowls come in a variety of different colors and textures. Fuel options include Natural Gas or Propane. Three sizes are also available with a water spout to combine running water with dancing flames (plumbing must be locally supplied). Compatible with the Pedestals (see page 23) allowing for additional decorating options.

V6

16" Star Burner

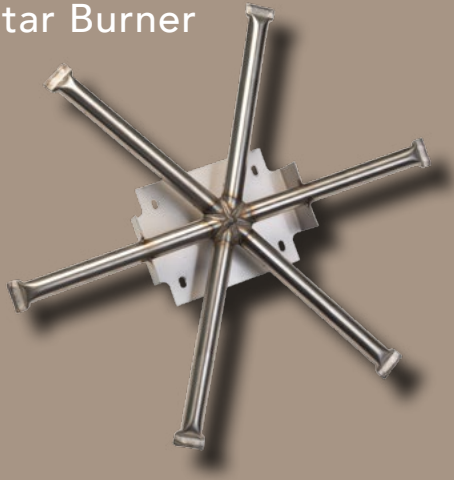

Also available, not shown:

24" Versailles Fire Bowl*

Model: 745-xx-11-V2xC
 Dimensions: 24" dia x 9 1/2" h
 BTU ratings: 60,000 (NG) / 50,000 (LP)

* Uses V2 -12" Star Burner

Feature Highlights

- Handcrafted from innovative Glass Fiber Reinforced Concrete (GFRC)
- Low profile with ball feet
- 16" stainless steel burner
- Available with water spout (32", 40" & 48" Models)
- Available for Natural Gas or Propane
- Compatible with Pedestals (see pg. 23) and Tank End Tables (see pg. 38)



48" Versailles Fire Bowl

Model Shown: 741-SD-11-V6xC
 Model w/Water Spout: 741-xx-80-V6xC
 Finish Shown: SD, Sedona
 Dimensions: 48" dia x 15" h
 BTU ratings: 65,000 (NG) / 60,000 (LP)



40" Versailles Fire Bowl

Model Shown: 742-SM-11-V6xC
 Model w/Water Spout: 742-xx-80-V6xC
 Finish Shown: SM, Smoke
 Dimensions: 40" dia x 14" h
 BTU ratings: 65,000 (NG) / 60,000 (LP)



32" Versailles Fire Bowl

Model Shown: 743-CB-11-V6xC
 Model w/Water Spout: 743-xx-80-V6xC
 Finish Shown: CB, Café Blanco
 Dimensions: 32" dia x 11 1/4" h
 BTU ratings: 65,000 (NG) / 60,000 (LP)

See pages 34-39 for available media, accessories and finish options

Marseille Fire Bowls



Pictured above:

- 48" Marseille Fire Bowl with Water Spout (751-BA-80-V6xC) in Black Lava Finish & 54" Pedestal (8654-CB) in Café Blanco Finish
- 40" Marseille Fire Bowl (752-BA-11-V6xC) in Black Lava Finish & 44" Pedestal (8644-CB) in Café Blanco Finish

Pictured above: 40" Marseille Fire Bowl (752-CB-11-V6xC) in Café Blanco Finish with Lava Coals (LFC-10)

The Marseille Fire Bowl offers a simple interpretation of the Fire Bowl concept, with a reduced profile and wider opening to accommodate a larger amount of fire media. Handcrafted from glass fiber reinforced concrete (GFRC), the Marseille Fire Bowls come in a variety of different colors and textures. Fuel options include Natural Gas or Propane. Three sizes are also available with a water spout to combine running water with dancing flames (plumbing must be locally supplied). Compatible with the Pedestals (see page 23) allowing for additional decorating options.

V6

16" Star Burner

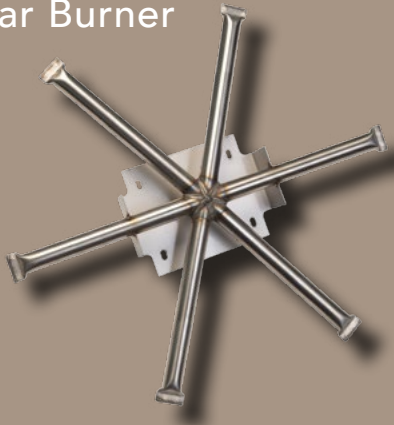

Also available, not shown:

24" Marseille Fire Bowl*

Model: 755-xx-11-V2xC
Dimensions: 24" dia x 6 1/2" h
BTU ratings: 60,000 (NG) / 50,000 (LP)

* Uses V2 -12" Star Burner

Feature Highlights

- Handcrafted from innovative Glass Fiber Reinforced Concrete (GFRC)
- Low profile
- 16" stainless steel burner
- Available with water spout (32", 40" & 48" Models)
- Available for Natural Gas or Propane
- Compatible with Pedestals (see pg. 23) and Tank End Tables (see pg. 38)



48" Marseille Fire Bowl

Model Shown: 751-CB-11-V6xC
Model w/Water Spout: 751-xx-80-V6xC
Finish Shown: CB, Café Blanco
Dimensions: 48" dia x 10 1/2" h
BTU ratings: 65,000 (NG) / 60,000 (LP)



40" Marseille Fire Bowl

Model Shown: 752-SD-11-V6xC
Model w/Water Spout: 752-xx-80-V6xC
Finish Shown: SD, Sedona
Dimensions: 40" dia x 11" h
BTU ratings: 65,000 (NG) / 60,000 (LP)



32" Marseille Fire Bowl

Model Shown: 753-SM-11-V6xC
Model w/Water Spout: 753-xx-80-V6xC
Finish Shown: SM, Smoke
Dimensions: 32" dia x 8 1/2" h
BTU ratings: 65,000 (NG) / 60,000 (LP)

See pages 34-39 for available media, accessories and finish options

Pedestals

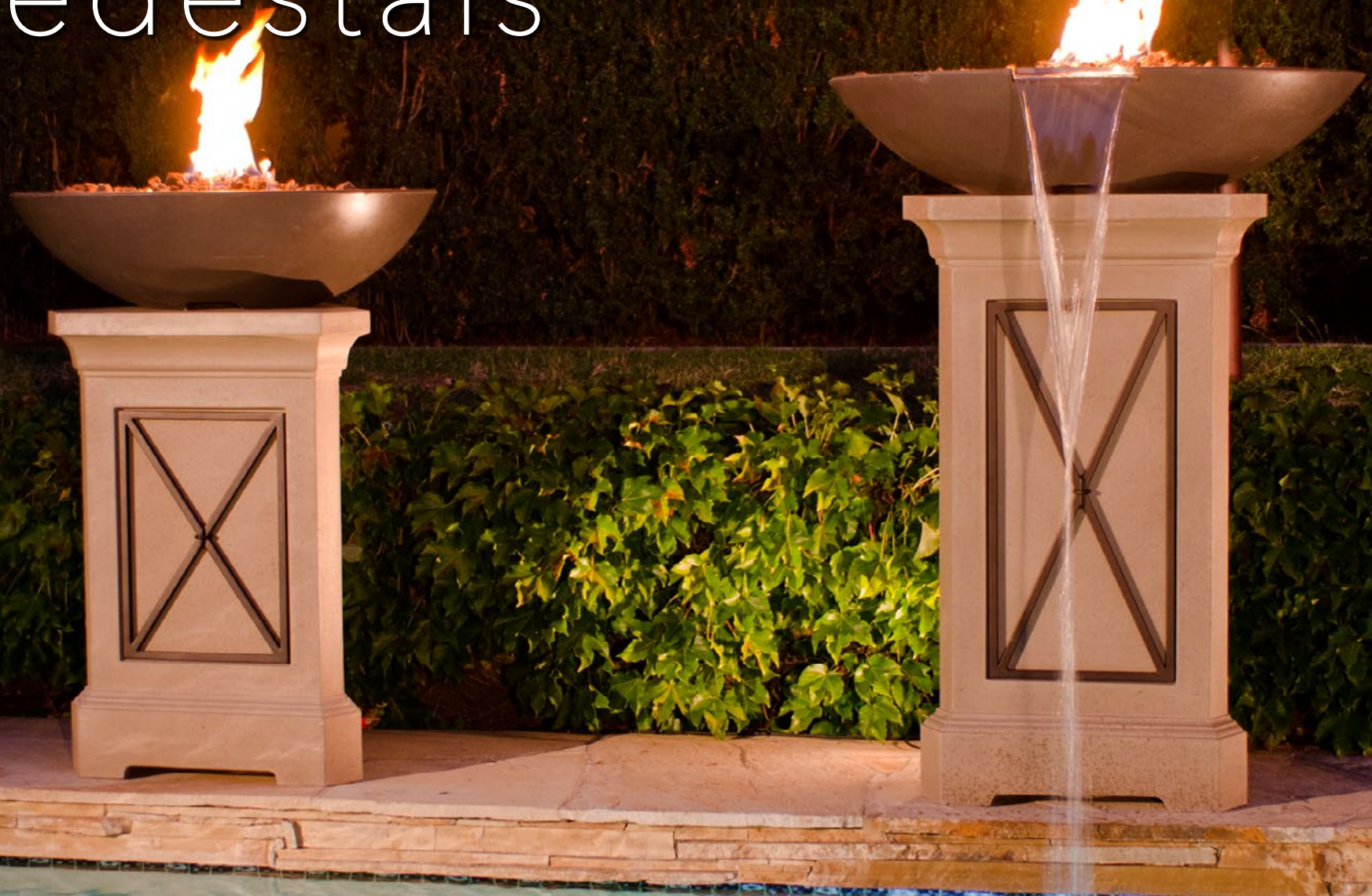

Pictured above:

- 48" Marseille Fire Bowl with Water Spout (751-BA-80-V6xC) in Black Lava Finish & 54" Pedestal (8654-CB) in Café Blanco Finish
- 40" Marseille Fire Bowl (752-BA-11-V6xC) in Black Lava Finish & 44" Pedestal (8644-CB) in Café Blanco Finish

Feature Highlights

- Available in Heavy Texture Finishes only
- Access door to accommodate a 5 gallon Propane tank (*not included*)
- Pedestals are compatible with all Versailles and Marseille Fire Bowls (*sold separately, see pages 18-21*)



44" Pedestal

Model Shown: 8644-CB
Finish Shown: CB, Café Blanco
Dimensions: 44" h x 28" w
Fire Bowl Shown: 742-CB-11-V6xC



54" Pedestal

Model Shown: 8654-SM
Finish Shown: SM, Smoke
Dimensions: 54" h x 28" w
Fire Bowl Shown: 741-SM-11-V6xC

This three-sided Pedestal is made to elevate the fire bowls to add height and grandeur. Made of glass fiber reinforced concrete (GFRC) with a stainless steel "X" set into the side-recessed portions of the pedestal, this item comes in a variety of different colors. The Pedestal accepts a five-gallon Propane tank and is compatible with all Versailles and Marseille Fire Bowls.

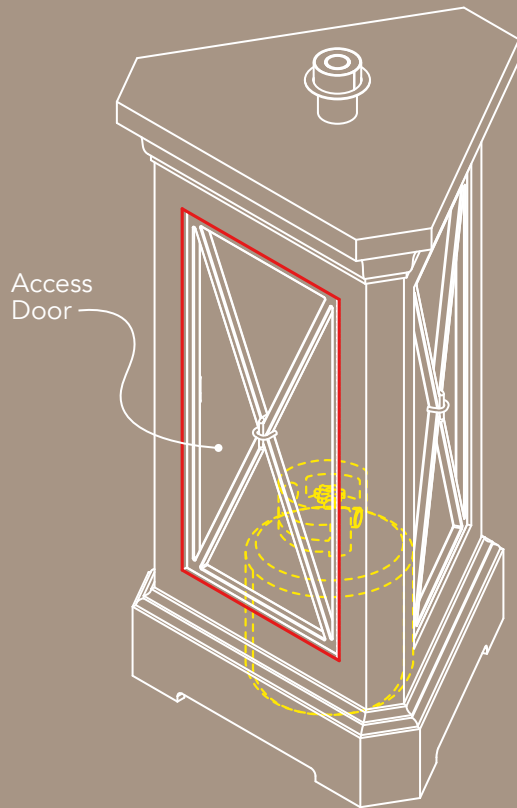

Artisan Glass Edition

HAND LAID TILE OPTIONS



Blue-tone Offset Glass (-31)



Earth-tone Small Pebbles (-51)



Mirror Glass Chip (-41)



Multi-color LED lights
on Firefalls



Glass Wind Guards included
with Large Firefalls



Pictured above: Artisan Glass Edition Small Firefall (699-BA-32-V5xC) in Black Lava Finish with Blue-Tone Offset Glass option & Clear Diamond Nuggets (GLD-xx-C)

Select American Fyre Designs™ models are available in Artisan Glass Edition versions featuring an artist-inspired mosaic of glass pieces embedded into the concrete mold of the fire feature. Each piece of glass is hand-laid and grouted to create an intricate and unique design for each and every item. Three different variations of glass mosaics are available.

Feature Highlights

- Hand-laid glass tiles
- Handcrafted from innovative Glass Fiber Reinforced Concrete (GFRC)
- Cascading water feature on Firefalls
- Finished Back
- Multi-color LED lights on Firefalls
- Glass Wind guards included with Large Firefalls
- Stainless steel burner
- Available for Natural Gas or Propane

Also available, not shown:

Firewall Artisan Glass Edition

Model: 093-xx-**-V4xC
 Dimensions: 60" w x 26" d x 60" h
 BTU ratings: 60,000 (NG) / 50,000 (LP)

Firewall is available in Heavy Texture Finishes only and does not have a water feature.



Large Firefall Artisan Glass Edition

Model Shown: 694-CB-62-V5xC
 Finish Shown: CB, Café Blanco
 Artisan Glass Shown: 61, Mirror Chip & Pebbles
 Dimensions: 65" w x 27 ¾" d x 73" h
 BTU ratings: 45,000 (NG) / 45,000 (LP)



Amphora Firetable Artisan Glass Edition

Model Shown: 612-SD-51-V2xC
 Finish Shown: SD, Sedona
 Artisan Glass Shown: 51, Earth-tone Small Pebbles
 Dimensions: 48" dia x 24" h
 BTU ratings: 60,000 (NG) / 50,000 (LP)



Small Firefall Artisan Glass Edition

Model Shown: 699-BA-32-V5xC
 Finish Shown: BA, Black Lava
 Artisan Glass Shown: 31, Blue-tone Glass Offset
 Dimensions: 47 ½" w x 25 ¾" d x 51 ½" h
 BTU ratings: 35,000 (NG) / 35,000 (LP)
Note: Small Firefall cannot accommodate a Propane tank inside the unit, see page 38 for tank housing options.



Inverted Firetable Artisan Glass Edition

Model Shown: 631-BA-31-V2xC
 Finish Shown: BA, Black Lava
 Artisan Glass Shown: 31, Blue-tone Glass Offset
 Dimensions: 48" dia x 24" h
 BTU ratings: 60,000 (NG) / 50,000 (LP)

Nest Collection



Pictured Above: Three Nest Lanterns (715-SD-11-V1xC) in Sedona Finish

The pieces in the Nest collection feature brushed stainless steel nest patterns in the design. The bodies of these pieces are made from glass fiber reinforced concrete (GFRC) and come in a variety of different colors and textures. Fuel options include Natural Gas or self-contained Propane tank.

V1 Burner



Creates whirlwind effect inside the Nest Lantern

V2 12" Burner



V4 24" Burner



Feature Highlights

- Brushed stainless steel nest pattern
- Handcrafted from innovative Glass Fiber Reinforced Concrete (GFRC)
- Stainless steel burner
- Available for Natural Gas or Propane
- Removable door to house a 5 gal. Propane tank
- Nest Lantern available with Electronic Ignition with wireless remote



Nest Square Firetable

Model Shown: 711-SL-11-V2xC
 Finish Shown: SL, Silverado
 Dimensions: 36" w x 36" d x 24" h
 BTU ratings: 60,000 (NG) / 50,000 (LP)



Nest Lantern

Model Shown: 715-CB-11-V1xC
 with EPK Valve -01: 715-xx-11-E1xx* (battery powered)
 with Smart Valve -05: 715-xx-11-S1xx* (requires line voltage)
 Finish Shown: CB, Café Blanco
 Dimensions: 16" w x 16" d x 66" h
 V1 burner BTU ratings: 30,000 (NG) / 20,000 (LP)



Nest Rectangle Firetable

Model Shown: 712-SL-11-V4xC
 Finish Shown: SL, Silverado
 Dimensions: 48" w x 28" d x 24" h
 BTU ratings: 60,000 (NG) / 50,000 (LP)

*BTU ratings for EPK & Smart Valves: 26,000 (NG) / 22,000 (LP)

Fire Urns



Pictured Above: Amphora Fire Urn (660-SD-11-V2xC) in Sedona Finish with Lava Granules (2-LFC-10)

One of our most popular pieces, the Amphora Fire Urn is reminiscent of the Grecian urns of old but features bursts of fire out the top. Several of these can be displayed down a path or placed near a fireplace or other outdoor feature to add sophisticated elegance to your outdoor area. Made from glass fiber reinforced concrete (GFRC), these urns come in a variety of different colors and textures. Fuel options include Natural Gas or self-contained Propane tank (Amphora & Piage Fire Urns are made with a removable door to house a 5 gallon Propane tank).

V2

12" Star Burner



Feature Highlights

- Handcrafted from innovative Glass Fiber Reinforced Concrete (GFRC)
- 12" stainless steel burner
- Available for Natural Gas or Propane
- Removable door to house a 5 gal. Propane tank (except Etruscan Fire Urn)



Amphora Fire Urn

Model Shown: 660-SD-11-V2xC
Finish Shown: SD, Sedona
Dimensions: 22" dia x 29" h
BTU ratings: 60,000 (NG) / 50,000 (LP)



Piage Fire Urn & Pedestal

Model Shown: 765-SD-11-V2xC
Finish Shown: SD, Sedona
Dimensions: 26" w x 19" d x 58" h
BTU ratings: 60,000 (NG) / 50,000 (LP)
Available in Heavy Texture Finishes only



Etruscan Fire Urn

Model Shown: 762-BA-11-V2xC
Finish Shown: BA, Black Lava
Dimensions: 26 ½" dia x 27" h
BTU ratings: 60,000 (NG) / 50,000 (LP)
Available in Heavy Texture Finishes only

Contemporary Fire Urns



Pictured Above:

- 48" Lotus Dining Firetable (652-BA-13-V2xC) in Black Lava Finish with Clear Diamond Nuggets (GLD-xx)
- Two Wave Urns (530-BA-10-V2xC) in Black Lava Finish with Clear Diamond Nuggets (GLD-xx)

Contemporary Fire Urns

Feature Highlights

- Handcrafted from innovative Glass Fiber Reinforced Concrete (GFRC)
- 12" stainless steel burner
- Available for Natural Gas or Propane
- Available in Heavy Texture Finishes



Eclipse Fire Urn

Model Shown: 520-SM-10-V2xC
Finish Shown: SM, Smoke
Dimensions: 23" dia x 37 ½" h
BTU ratings: 60,000 (NG) / 50,000 (LP)



Wave Fire Urn

Model Shown: 530-BA-10-V2xC
Finish Shown: BA, Black Lava
Dimensions: 20" dia x 37 ½" h
BTU ratings: 60,000 (NG) / 50,000 (LP)

New to American Fyre Designs™, Wave and Eclipse contemporary Fire Urns add warmth and modern styling to your outdoor living space. Made from glass fiber reinforced concrete (GFRC), contemporary urns come in a variety of Heavy Texture Finishes. Choose from Natural Gas or Propane. These urns are made with a removable door to accommodate a 5 gallon Propane tank inside (not included).

V2

12" Star Burner



See pages 34 & 39 for available media and finish options

Fire Pits



Pictured above: Contractor's Model Firepit (685-CB-11-V2XC) in Café Blanco Finish w/stone veneer

Our artistically-designed fire pits add style and design to the classic outdoor fire pit. The Chiseled Fire Pit has a rough hewn concrete exterior and smooth rim around the top. The El Dorado Fire Pit has a smooth concrete exterior and smooth rim around the top. The Contractor's Model comes as a blank slate for you to customize and design your way by adding your own stone, tile or other veneer. Made from glass fiber reinforced concrete (GFRC), these fire pits come in a variety of different colors. Fuel options include Natural Gas or Propane.

V6

16" Star Burner



Feature Highlights

- Handcrafted from innovative Glass Fiber Reinforced Concrete (GFRC)
- 16" stainless steel burner
- Available for Natural Gas or Propane (Propane models, see page 38 for tank housing options)



Chiseled Fire Pit

Model Shown: 680-SD-11-V6xC
 Finish Shown: SD, Sedona
 Dimensions: 39" dia x 14 1/2" h
 BTU ratings: 65,000 (NG) / 60,000 (LP)



El Dorado Fire Pit

Model Shown: 681-CB-11-V6xC
 Finish Shown: CB, Café Blanco
 Dimensions: 39" dia x 14 1/2" h
 BTU ratings: 65,000 (NG) / 60,000 (LP)



Contractor's Model Fire Pit

Model Shown: 685-CB-11-V6xC
 Finish Shown: CB, Café Blanco
 Dimensions: 39" dia x 14 1/2" h
 BTU ratings: 65,000 (NG) / 60,000 (LP)
 Add your own stone veneer for a custom look

See pages 34-39 for available media, accessories and finish options

Media



Fyre Glass



GL-xx-F
Azuria



GL-xx-FR
Azuria
Reflective



GL-xx-B
Black



GL-xx-Z
Bronze



GL-xx-ZR
Bronze
Reflective



GL-xx-BR
Black
Reflective



GL-xx-E
Emerald



GL-xx-ER
Emerald
Reflective



GL-xx-HR
Gold
Reflective



GL-xx-N
Caribbean Blue



GL-xx-NR
Caribbean Blue
Reflective



GL-xx-QR
Copper
Reflective



GL-xx-C
Clear



GL-xx-W
Star Fyre



GL-xx-S
Sapphire

Fyre Gems



GLG-xx-A
Deep Amber



GLG-xx-J
Black Pearl



GLG-xx-E
Emerald



GLG-xx-B
Black Granite



GLG-xx-D
Champagne



GLG-xx-C
Glacier



GLG-xx-M
Mint



GLG-xx-S
Sapphire



GLG-xx-P
Platinum



GLG-xx-T
Blue Topaz

Nuggets



GLD-xx-C
Clear



GLD-xx-E
Emerald



GLD-xx-L
Lavender



GLD-xx-R
Rosé



GLD-xx-SB
Steel Blue



GLD-xx-PB
Pacific Blue

Gas Logs & Lava



CHD-xx
Charred Oak
(Vented)*



CHFR-xx
Charred Frontier Oak
(Vent Free)*



PRO-27
Prairie Oak



OCL-34
Campfire Logs



OCBW-34
Beachwood Logs



VS-25
Volcanic Stones



STN-20
20-pc. Designer
River Rocks



WCD-36
36-pc. Wood
Chunks



BDC-4
Charred Branches



LFC-10
Lava Coals



LF-10
Lava Granules

Due to the manufacturing process, glass color shade and density will vary.

*Charred Oak & Charred Frontier Oak gas logs are for Fireplaces only. Burners systems sold separately.

Protective Covers

GFRC Covers

Manufactured out of the same Glass Fiber Reinforced Concrete (GFRC), these protective covers are designed to fit over the firetable opening protecting the burner assembly against wind and rain. They also provide additional table surface when the burner is not in use.

Fabric Covers

Manufactured with a heavy duty, multi-layer PVC exterior, these covers are custom fit for selected Firetables, Fire Bowls, Fire Urns and the Nest Lantern. The black PVC material has been tested and proven for color-fastness.

Additional Covers not pictured

GFRC Cover	Fabric Cover
<ul style="list-style-type: none"> • 8105-xx, Contempo Round Firetable • 8106-xx, Amphora Fire Urn • 8107-xx, Etruscan Fire Urn • 8108-xx, Piage Fire Urn • 8123-xx, Cosmopolitan Square Dining Table 	<ul style="list-style-type: none"> • 8137-xx, Cosmopolitan Square Dining Table • 8138-xx, Cosmopolitan Rectangle Firetable • 8139-xx, Contempo Rectangle Firetable



Round GFRC Cover

Model: **8100-xx**

Fits: Chat Ht. Octagon Firetable, Fiesta Firetables, Inverted Firetables, Amphora Firetables & Cosmopolitan Round Firetable



Square GFRC Cover

Model: **8120-xx**

Fits: Cosmopolitan Square Firetable, Voro Firetable, Nest Firetable & Contempo Square Firetable

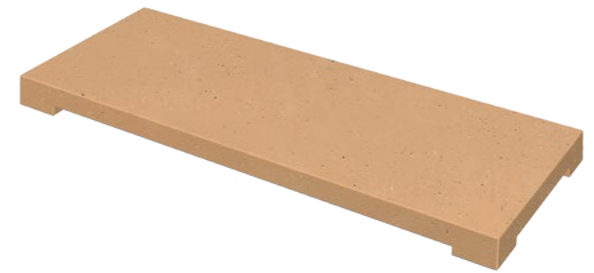

Rectangular GFRC Cover

Model: **8110-xx**

Fits: Rectangular Firetable, Nest Rectangular Firetable, Cosmopolitan Rectangle Firetable & Contempo Rectangle Firetable



54"/60" Round Firetable Cover

Model: 8131A

Fits: Chat Ht. Octagon Firetable, Fiesta Firetables & Inverted Dining Firetable



36" Square Firetable Cover

Model: 8132A

Fits: Cosmopolitan Square Firetable, Voro Firetable & Nest Firetable



48" Round Firetable Cover

Model: 8135A

Fits: Amphora Firetable, Inverted Firetable, Cosmopolitan Round Firetable & 48" Fire Bowl



Amphora Fire Urn Cover

Model: 8133A

Fits: Amphora Fire Urn



Rectangular Firetable Cover

Model: 8136A

Fits: Rectangular Firetable & Nest Rectangular Firetable



Fire Pit Cover

Model: 8140A

Fits: Chiseled Fire Pit, El Dorado Fire Pit & Contractor's Model Fire Pit



Fire Bowl Cover

Model: 8140A

Fits: 36" Fire Bowl, 40" Versailles Fire Bowl & 40" Marseille Fire Bowl



Nest Lantern Cover

Model: 8134A

Fits: Nest Lantern

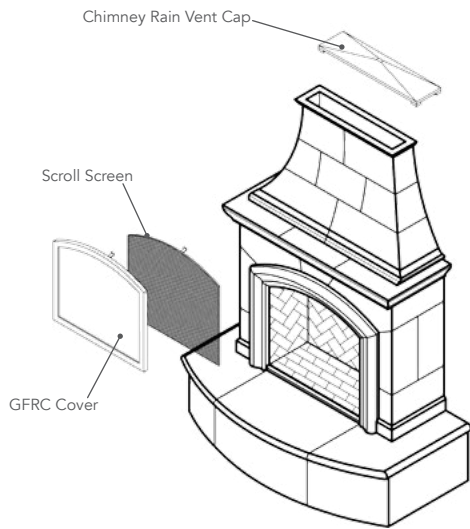

Chimney Rain Vent cap

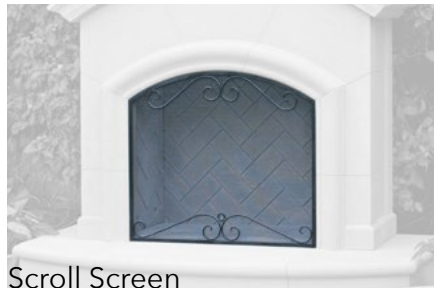

Scroll Screen



Protector Plate



Model: 8200-CB
Fits: Phoenix, Phoenix w/Back Venting, Grand Phoenix, Mariposa & Grand Mariposa



Model: 8205-CB
Fits: Petite Cordova & Grand Petite Cordova



Model: 8210-CB
Fits: Cordova, Reduced Cordova & Grand Cordova



Model: 8220-CB
Fits: Chica

Tank End Tables



Amphora tank/end table
Model Shown: 8500-CB
Finish Shown: CB, Café Blanco
Dimensions: 24" dia x 19 ¼" h



Contempo tank/end table
Model Shown: 8510-SD
Finish Shown: SD, Sedona
Dimensions: 17" dia x 19 ¼" h



Rain Drum tank/end table
Model Shown: 8199-CB
Finish Shown: CB, Café Blanco
Dimensions: 21 ¾" dia x 22 ¼" h



10 ft. Propane Extension Hose
Model: 5110-26

Glass Wind Guards



Square Glass Wind Guard
Model: 8202-WG



Rectangular Glass Wind Guard
Model: 8204-WG



Firefall Glass Wind Guard
Model: 8206-WG

Heavy Texture Finishes



Café Blanco (CB)

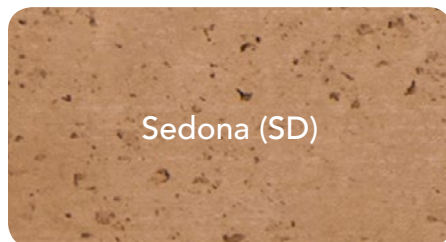

Sedona (SD)

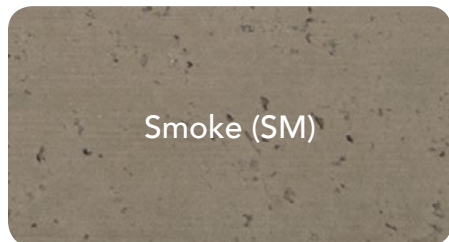

Smoke (SM)



Black Lava (BA)

Sand Finishes



Canyon (CN)



Villa (VA)

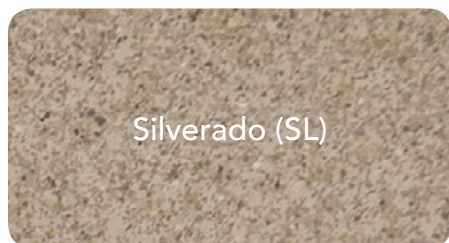

Silverado (SL)



Tuscan Slate (TS)

Product Description	Heavy Texture	Sand
Fireplaces		
Cordova	●	●
Reduced Cordova	●	●
Petite Cordova	●	●
Grand Cordova	●	●
Grand Petite Cordova	●	●
Phoenix	●	●
Phoenix w/Back Venting	●	●
Grand Phoenix	●	●
Mariposa	●	●
Grand Mariposa	●	●
Chica	●	●
Manhattan Fireplace	●	●
Contractor's Model		
Contractor's Model w/ Moulding		White Concrete Only
Firefalls		
Large Firefalls	●	●
Small Firefalls	●	●
Archstone Firewalls	●	
Firetables		
Amphora Firetables	●	●
Contempo Firetables	●	
Cosmopolitan Firetables	●	●
Elliptical Firetable	●	
Fiesta Firetables	●	●
Inverted Firetables	●	●
Lotus Firetables	●	
Nest Firetables	●	●
Octagon Firetables	●	●
Rectangular Firetable	●	
Versailles Firetable	●	
Voro Firetable	●	●
Fire Bowls		
Fire Bowls	●	
Versailles Fire Bowls	●	
Marseille Fire Bowls	●	
Pedestals	●	
Fire Pits		
Chiseled Fire Pit	●	
El Dorado Fire Pit	●	
Contractor's Model Fire Pit	●	
Fire Urns & Lantern		
Amphora Fire Urn	●	●
Etruscan Fire Urn	●	
Piage Fire Urn & Pedestal	●	
Eclipse Fire Urn	●	
Wave Fire Urn	●	
Nest Lantern	●	●

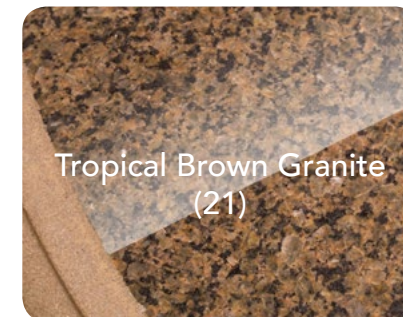

Tropical Brown Granite (21)

Granite Inset Option for:

- Amphora Firetable (Model 611)
- Inverted Firetable (Model 630)
- Inverted Dining Firetable (Model 676)
- Octagon Firetable (Model 625)

Artisan Glass Edition

Hand Laid Tile Options



Blue-tone Offset Glass (-31)



Earth-tone Small Pebbles (-51)



Mirror Glass Chip (-41)

Note: American Fyre Designs™ products are individually handcrafted and finishes shown are subject to slight texture and color variation.

AMERICAN FYRE DESIGNS™ LIMITED WARRANTY HIGHLIGHTS

THREE (3) YEAR WARRANTY

AMERICAN FYRE DESIGNS™ EXTERIOR (GFRC) FIRE FEATURES AND ACCESSORIES ARE WARRANTED FOR **THREE (3) YEARS**

ONE (1) YEAR WARRANTY

ALL AMERICAN FYRE DESIGNS™ VALVES, BURNERS, ELECTRICAL COMPONENTS, AND CONTROLS (EXCLUDING BATTERIES) ARE WARRANTED FOR **ONE (1) YEAR**

THIS WARRANTY APPLIES TO THE ORIGINAL PURCHASER WITH INVOICE OR PROOF OF PURCHASE AND TO SINGLE FAMILY RESIDENTIAL USE ONLY. FOR ADDITIONAL INFORMATION REGARDING THIS WARRANTY, OR TO PLACE A WARRANTY CLAIM CONTACT YOUR AUTHORIZED AMERICAN FYRE DESIGNS™ DEALER

Diagrams, illustrations and photographs are not to scale – consult installation instructions.

Product designs, materials, dimensions, specifications, colors and prices are subject to change or discontinuance without notice.

**AMERICAN
FYRE DESIGNS™**
outdoor Products collection

14724 Proctor Ave • City of Industry, CA 91746

Phone (626) 369-5085 • Fax (626) 369-5979

www.americanfyredesigns.com